

LARGE DISPLAY PROCESS METERS

Model PD650 NEMA 4X 2.3" High LED



Model PD655 NEMA 4X 1.0" High LED



Model PD656 Exp-Proof 4X 0.8" High LED



- 4-20 mA, 1-5 V, 0-5 V, 0-10 V inputs
- 4½ digit + extra zero display for rate
- 6 digit display for total
- Programmable exponent for weirs & flumes
- Pump alternation control
- Two 24 VDC transmitter power supplies
- 200 mA transmitter power supply option
- 2 or 4 relays & 4-20 mA output options
- 115 VAC or 230 VAC power
- Operating temperature: -20 to 65°C

GENERAL FEATURES

The PD650, PD655 and PD656 are Large Display Process Meters with flow rate, totalizer and batch control capabilities. Each accepts the common process signals such as 4-20 mA, 0-5 VDC, 1-5 VDC and 0-10 VDC and displays these signals in engineering units on a large, high efficiency, 4½ digit red LED display. All units also provide two isolated 24 V power supplies to drive both the input and output loops. Options include up to 4 relays for alarms or batch controlling, as well as an isolated 4-20 mA transmitter output.

Key Features

- Two 24 VDC isolated transmitter power supplies
- 115 or 230 VAC field selectable power
- Rate display in units per day, in addition to second, minute and hour
- Programmable setpoints for latching/non-latching relay operation
- Built-in snubbers on each relay contact
- Any set point programmable for process/rate or total
- Programmable exponent for weirs and flumes
- Pump Alternation (PD655 & PD656 Only)

Single Button Scaling

Single button scaling means that these meters can be completely programmed using only one button. Simply press the **ENTER** button to initiate the automatic menu scan. When the desired menu appears press the **ENTER** button again. Once in a menu, press the **ENTER** button when the display reads the desired value. To exit setup & programming press the **ACK** (Acknowledge) button while displaying any of the main menus. It's that simple!

Stand Alone Scaling (Internal or External)

These meters may be scaled without a signal source or calibrated with a signal source.

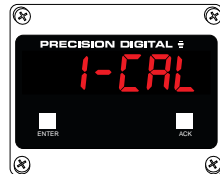

Lockout and Menu-Title Disabling

The ability to modify programming values can be restricted by installing a lockout jumper on terminals at the rear of the instrument. In addition, certain menu titles can be programmed not to appear during the menu scroll.

Menu titles that can be excluded with dSPY menu functions.

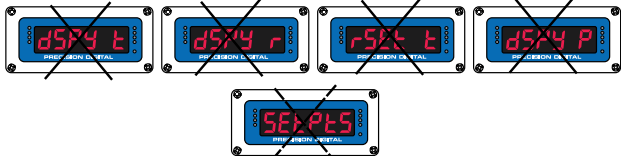

SEtPt5 Menu title always appears.

Ability to change values may or may not be restricted

Functions that can be locked out with the lockout jumper.

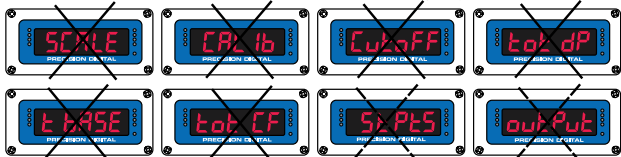

Large, Bright, Red LEDs

The large, bright, red LED display of these Large Display Process Meters is designed to make them easily read from far away in a dimly lit process plant.

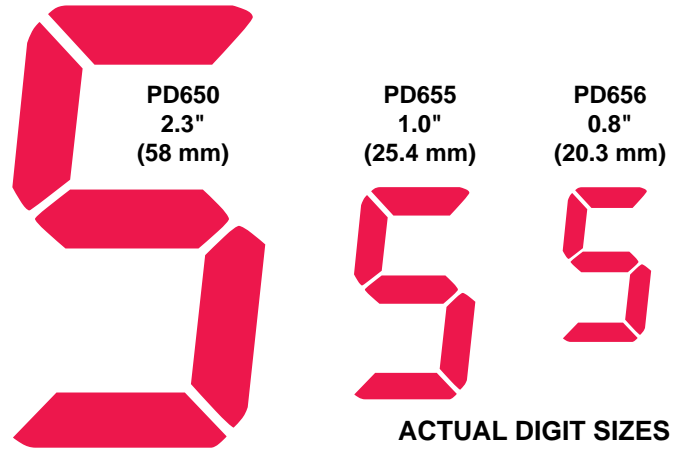

ACTUAL DIGIT SIZES

Simplify Loops with Two 24 V Supplies

The PD650, PD655 and PD656 are ideal for loops that consist of a transmitter, a digital meter and a DCS or computer because they can provide isolated power to drive both the input and output loops.

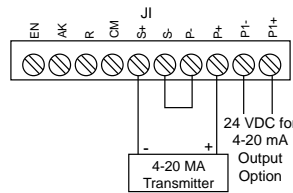

Transmitter Powered from Internal Power Supply

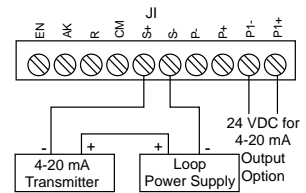

Transmitter Powered from External Power Supply

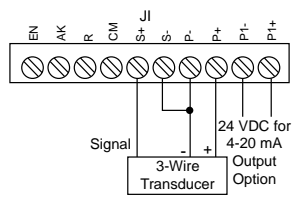

Transducer Powered from Internal Power Supply

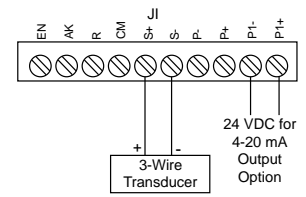

Direct Voltage Signal Connections

Universal Process Inputs & Linearization

The Large Display Process Meters accept both voltage and current inputs and can be scaled for virtually any engineering unit. In Addition, these meters feature automatic square root extraction, programmable exponent for weirs and flumes and 11-point custom calibration.

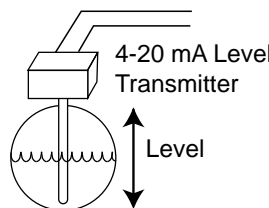

Display volume in a round horizontal tank.

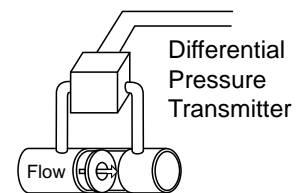

Display flow rate by extracting the square root of a signal from a DP transmitter.

FLOW FEATURES

The Large Display Process Meters may be used to display flow rate and total from a wide variety of flow meters. For flow rate applications, these meters feature programmable time base of seconds, minutes, hours, or days, a 4½ digit plus extra zero display, and low-flow cutoff capability. For total applications, these meters feature a full six-digit display, a programmable totalizer conversion factor and the ability to automatically or manually toggle back and forth between rate and total display. New features include programmable exponent for weirs and flumes.

OPTIONS

The PD655 and PD656 Meters can be equipped with 2 or 4 SPDT relays and 4-20 mA output options. Any relay can be assigned to the rate or the total. The 4-20 mA output on provides signal isolation and can be scaled for a wide variety of applications.

Rate Relays

Rate relays are field programmable as latching or non-latching and 0-100% adjustable deadband. They can be used as high or low alarms or for simple on-off control, such as sump-pump control. Pairs of rate relays can also be programmed to alternate making these meters ideal for duplex pumping applications.

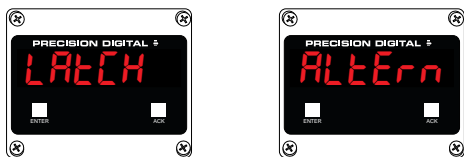

Total Relays

Total relays can be programmed for manual (E for External Reset) or automatic (I for Internal Reset) batch control. To simplify and speed up batch-size changes, total relays can be programmed so the first preset always trips at a user-defined offset value before the main preset trips. In addition, the Priority Batch Programming feature allows the user to program the batch presets without having to go through the entire menu. Simply hold the ENTER button for three seconds and the meter jumps right to the batch presets.

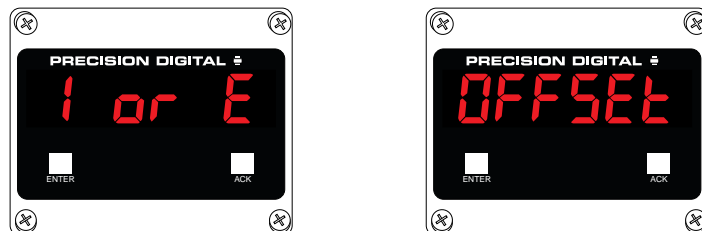

4-20 mA Output Option

The PD655 and PD656 Meters can be equipped with an isolated 4-20 mA output signal option that can be programmed to produce a 4-20 mA output for virtually any input. These meters also contain two transmitter power supplies so even if the meter is powering the input loop, it can still power the output loop. The 4-20 mA output provides 500 VDC or peak AC, input-to-output or input/output-to-power isolation.

PUMP ALTERNATION

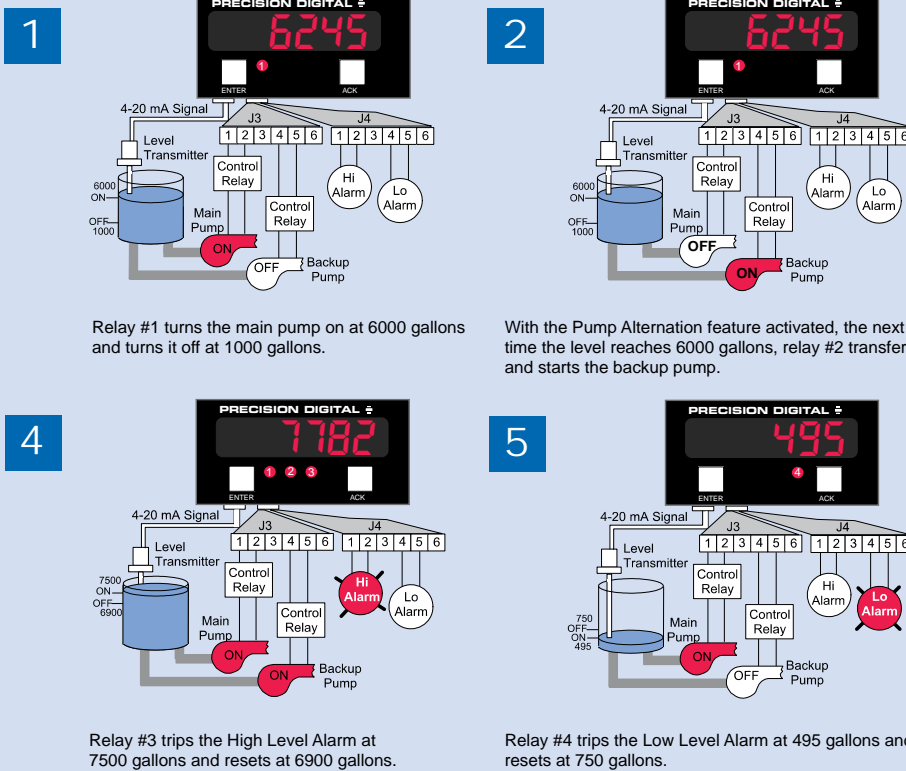

Relay #1 turns the main pump on at 6000 gallons and turns it off at 1000 gallons.

With the Pump Alternation feature activated, the next time the level reaches 6000 gallons, relay #2 transfers and starts the backup pump.

If backup pump is not able to keep up, and the level reaches 7000 gallons, relay #1 transfers and starts the main pump as well

Relay #3 trips the High Level Alarm at 7500 gallons and resets at 6900 gallons.

Relay #4 trips the Low Level Alarm at 495 gallons and resets at 750 gallons.

PD655 & PD656 OPTION CARD PIN-OUTS









Jumper	Pin	Function
J1	1	Transmitter +
	2	Transmitter -
J3	1	Relay #1 Common
	2	Relay #1 NC
	3	Relay #1 NO
	4	Relay #2 Common
	5	Relay #2 NC
	6	Relay #2 NO
J4	1	Relay #3 Common
	2	Relay #3 NC
	3	Relay #3 NO
	4	Relay #4 Common
	5	Relay #4 NC
	6	Relay #4 NO

Notes:

1. Alarm acknowledgement terminals (AC and COM) are located on the meter main board.
2. In the alarm condition, the NC contact is connected to common in the fail safe mode.

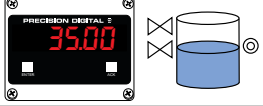
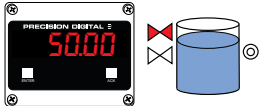
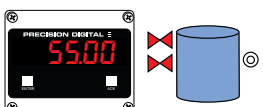
Manual Batch Control Operation

This example shows how the PD655 can be used for simple manual batch control.

	KEY
The valve and External Switch KEY Legend is as shown:	 = VALVE CLOSED  = VALVE OPEN  = External Reset Switch  = External Reset Switch Activated
Both valves are open to fill the barrel. Meter displays barrel contents.	
Full-flow valve #1 is closed and restricted-flow valve #2 "dribbles" in the remaining 5 gallons.	
When the total reaches 55.00, relay 2 trips and closes the restricted-flow valve #2. Display freezes on 55.00 and relays 1 and 2 will not reset until external switch is pushed.	
Both valves are still closed and a new barrel is positioned. Meter displays previous barrel's contents until external reset button is pushed	
Operator presses reset switch to reset total. Total goes to zero. Both relays reset causing both valves to open and begin filling the new barrel.	
Both valves are open to fill the barrel. Meter displays barrel contents.	

Explosion-Proof Control Stations for the PD656

The Explosion-proof Control Stations can be used to control the PD656 while in operation in a hazardous area.

Control stations may be ordered with one, two or three push buttons. The buttons can be labeled ENTER, ACK and RESET.

External connections are available at the J1 connector on the Main Board.

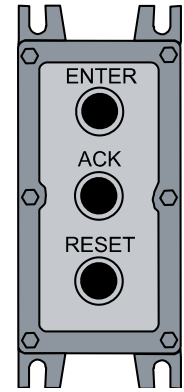

Front Panel LED Indicators

LED	During Programming:	During Operation:
1	Alarm 1	Alarm 1
2	Alarm 2	Alarm 2
3	Alarm 3	Alarm 3
4	Alarm 4	Alarm 4
S	Set Point Indicator	None
R	Reset Point Indicator	None
4	4 mA Output Indicator	None
20	20 mA Output Indicator	None
R	Rate Indicator	Rate

Front Panel LEDs for PD655



Magnetic Reed Switch Operation



The PD656 has two magnetic reed switches located above the **ENTER** and **ACK** buttons. The reed switches allow the user to program and operate the meter without having to remove the enclosure cover.

OVERALL DIMENSIONS

PD650

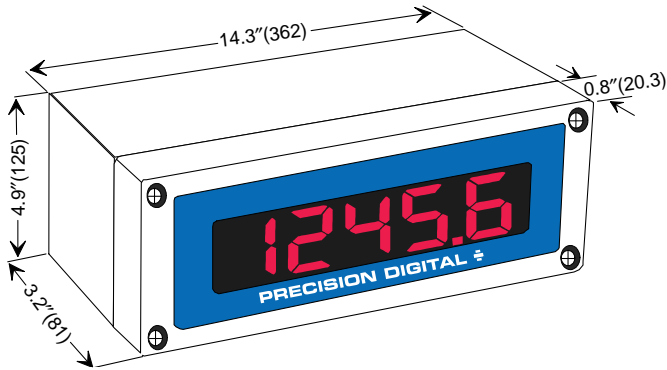

PD655



PD656

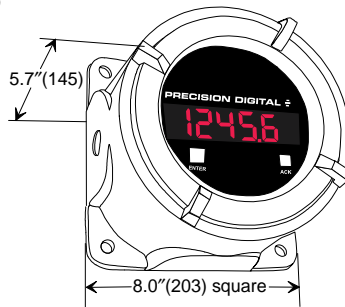

WALL MOUNTING

There are four mounting holes on the rear of the enclosure that are used to mount the instrument to a wall.

PD650

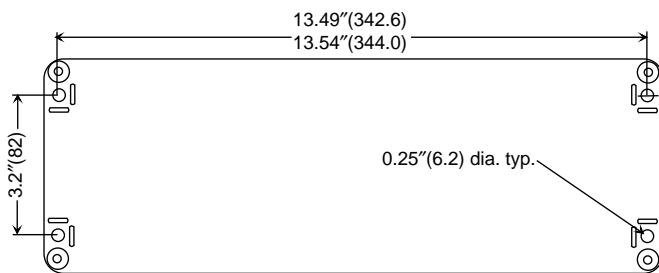

PD655

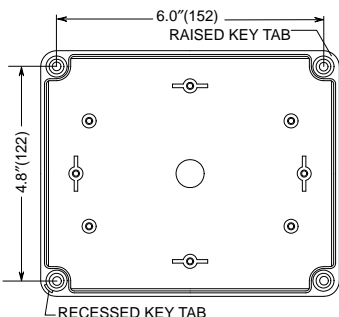

PD656

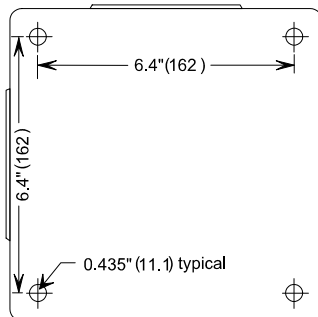

Designed for vertical or horizontal conduit entry.

PANEL MOUNTING

PD650 Panel Mounting Kit - PDA6504

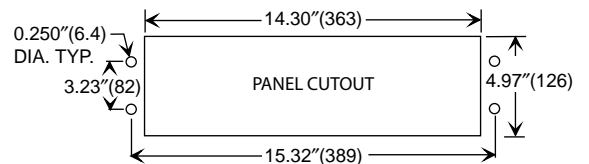
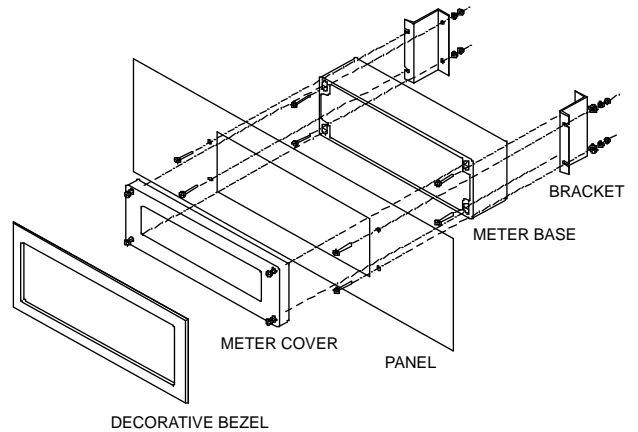

NOTES:

1. Allowable panel thickness: 0.06 - 0.25 (1.5 - 6.4). Longer bracket screws may be used for panel thickness up to 0.5 (12.7).
2. Mounting space required: 7 x 17.5 x 4 (178 x 445 x 102) (H x W x D). Meter cover extends 0.8 (20) - X from the surface of the panel, where X equals the thickness of the panel.
3. This panel mounting kit is not intended to provide waterproof protection to the panel.
4. All dimensions are in inches and millimeters (mm).

PD655 Panel Mounting Kit - PDA6554

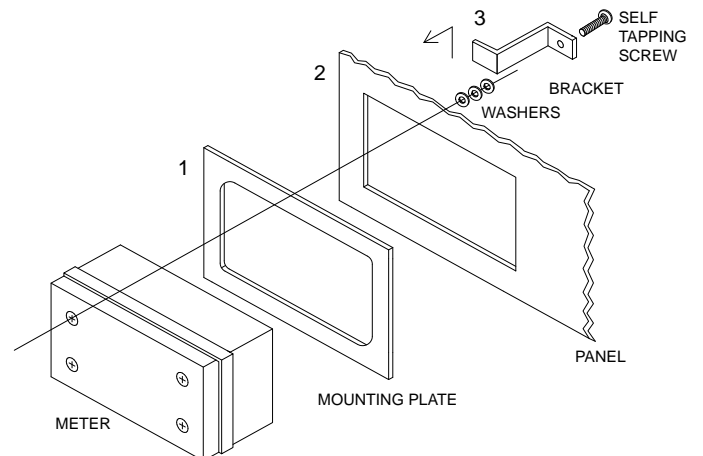

NOTES:

1. Mounting brackets require 0.8 (20) clearance on either top or side of meter for installation.
2. Tolerance for panel cutout dimensions are 0.01/-0.00(+0.3/-0.0).
3. Panel mounting kits are not intended to provide waterproof protection to the panel.
4. All dimensions are in inches and millimeters (mm).

PD650
NEMA 4X 2.3" Red LED



PD655
NEMA 4X 1.0" Red LED



PD656
Explosion-Proof 0.8" Red LED



ORDERING INFORMATION

PD650 • Large Display (3.2") Process Meter		
115/230 VAC Model	24 VDC Model	Options Installed
PD650-N	PD650-2-N	None
PD650-34	PD650-2-34	2 Relays
PD650-35	PD650-2-35	4-20 mA Output
PD650-36	PD650-2-36	2 Relays + 4-20 mA Output
PD650-37	PD650-2-37	4 Relays
PD650-38	PD650-2-38	4 Relays + 4-20 mA Output
PD650 Accessories		
PDA6504	Panel Mounting Kit for PD650	

PD655 • Large Display (1.0") Process Meter			
115/230 VAC Model	24 VDC Model	Options Installed	Option Card*
PD655-N	PD655-2-N	None	
PD655-44	PD655-2-44	2 Relays	PD474
PD655-45	PD655-2-45	4-20 mA Output	PD475
PD655-46	PD655-2-46	2 Relays + 4-20 mA Output	PD476
PD655-47	PD655-2-47	4 Relays	PD477
PD655-48	PD655-2-48	4 Relays + 4-20 mA Output	PD478
PD655 Accessories			
PDA6545	2" Pipe Mounting Kit for PD655		
PDA6554	Panel Mounting Kit for PD655		

PD656 • Large Display (0.8") Process Meter			
115/230 VAC Model	24 VDC Model	Options Installed	Option Card*
PD656-N	PD656-2-N	None	
PD656-44	PD656-2-44	2 Relays	PD474
PD656-45	PD656-2-45	4-20 mA Output	PD475
PD656-46	PD656-2-46	2 Relays + 4-20 mA Output	PD476
PD656-47	PD656-2-47	4 Relays	PD477
PD656-48	PD656-2-48	4 Relays + 4-20 mA Output	PD478
PD656 Accessories			
PDA2451-A	1 Button Control Station: ACK		
PDA2451-E	1 Button Control Station: ENTER		
PDA2451-R	1 Button Control Station: RESET		
PDA2452-EA	2 Button Control Station: ENTER & ACK		
PDA2452-ER	2 Button Control Station: ENTER & RESET		
PDA2453-EAR	3 Button Control Station: ENTER, ACK & RESET		
PDA6545	2" Pipe Mounting Kit for PD656		
PDA-MAG	Magnet Assembly for PD656		

*Part numbers for Option Cards when purchased separately. Listed models include the corresponding described option.

SPECIFICATIONS

Except where noted all specifications apply to operation at +25°C.

PD650 NEMA 4X 2.3" Red LED

Display: 2.3" (57.3 mm) red LED, 4½ digits, F or C can be selected on PD757 to indicate degrees Fahrenheit or Celsius.

Enclosure: Die-cast aluminum, NEMA 4X, IP66/IP67 Corrosion resistant, 0.1% max copper content, color: gray (RAL 7001) polyester powder paint. Four holes for ½" conduit provided at base, 3 plugs provided.

Mounting: Enclosure contains four ¼" (6.4 mm) holes for wall-mounting. Panel mounting kit available.

Overall Dimensions: 4.9" x 14.3" x 3.2" (125 x 362 x 81 mm)

Weight: 7.0 lb (3.2 kg)

PD655 NEMA 4X 1.0" Red LED

Display: 1.0" (25.4 mm) red LED, 4½ digits, F or C can be selected on PD755 to indicate degrees Fahrenheit or Celsius.

Enclosure: Impact-resistant glass-filled polycarbonate, NEMA 4X, IP67 (IEC 529), color: gray (RAL 7035). Two holes for ½" conduit provided at base.

Mounting: Enclosure contains four holes for wall-mounting. Panel mounting and 2" pipe mounting kits available.

Overall Dimensions: 6.7" x 5.5" x 3.7" (170 x 140 x 95 mm)

Weight: 3.8 lb (1.73 kg)

PD656 Explosion-Proof 0.8" Red LED

Display: 0.8" (20.3 mm) red LED, 4½ digits, F or C can be selected on PD756 to indicate Fahrenheit or Celsius.

Enclosure: Explosion-proof sand-cast aluminum with glass window, 0.3% max copper content, NEMA 4, 7, & 9, IP66.

UL Classified & CSA Certified Class I Groups C & D, Class II Groups E, F & G, Class III hazardous outdoor (Type 4) locations. Two ¾" NPT holes provided at opposite sides. Up to four holes can be provided for an additional charge.

Mounting: Enclosure contains four 7/16" (11.1 mm) holes for wall-mounting. A 2" pipe mounting kit is available.

Overall Dimensions: 8.0" x 8.0" x 5.7" (203 x 203 x 145 mm)

Weight: 14.6 lb (6.6 kg)

General

Alarm Points: Four, any combination of high or low alarms

Alarm Point Deadband: 0-100% FS, user selectable

Alarm Status Indication: Front panel LED

External Programming: The Enter button functions can be controlled externally by wiring a switch across terminals EN and CM.

Non-Volatile Memory: Settings stored for a minimum of 10 years.

Normal Mode Rejection: 64 dB at 50/60 Hz

Power Options: AC power: 115 or 230 VAC (field select) ±10%, 50/60 Hz, 12 VA. DC power: 22-28 VDC; 12 W maximum.

Isolation: AC powered: 1500 V; DC powered: 500 V

Connections: Removable screw terminals accept 12 to 22 AWG

Warranty: 2 years parts & labor

Extended Warranty: 1 or 2 years, refer to Price List for details.

Basic Meter Specifications

Inputs: Field selectable: 4-20 mA, 0-20 mA, 0-5 V, 1-5 V, 0-10 V

Display: 6 digits, red LED, -19,999(0) to 29,999(0) with selectable extra zero. Total display: 0 to 999,999.

Decimal Point: Process/rate: 2.9999, 29.999, 299.99, 2999.9 or 29999.0. Total: 9.99999, 99.9999, 999.999, 9999.99, 99999.9, 999999. Rate and total decimal points are independent.

Linear Input Accuracy: ±0.05% FS ±1 count

Root Function Accuracy: ±0.1% FS ±2 counts

Programmable Exponent: From 1.0001 to 2.9999

Multi-Point Linearization: 2 to 11 points

Calibration: May be scaled using internal calibration (*I- $\overline{E}RL$*) or calibrated by applying an external calibration signal (*E- $\overline{E}RL$*). To scale inputs such as 0-5 V, 1-5 V, or 0-10 V without applying a signal it is necessary to first complete an Initial Calibration.

Calibration Range: User programmable over entire range of meter

Input Range	Minimum Span Between Input 1 & Input 2
0-5 V.....	0.16 V
0-10 V.....	0.32 V
4-20 mA	1.60 mA

11-Point Linearization: Minimum span between inputs

Input Range	Minimum Span
4-20 mA	(1.6 mA / (Number of points -1))
0-5 V	(0.16 V / (Number of points -1))
0-10 V	(0.32 V / (Number of points -1))

e.g. Minimum span for an 11-point, 4-20 mA calibration is 0.16 mA between inputs.

Input Impedance: Voltage ranges: greater than 300 k Ω ; current ranges: 100 Ω

Transmitter Supply: Two isolated transmitter supplies, 24 VDC ±5% @ 20 mA each, regulated. Maximum loop resistance: 1200 Ω

Optional Transmitter Supply: One 18 VDC (nominal) @ 200 mA max; unregulated power supply can be provided instead of the two 24 VDC supplies (see Price List for modification number).

Max (Display Peak): Captures the maximum or peak process/rate and displays it via the front panel ENTER button (*dSPY P*)

Max Indication: Front panel flashing "R" LED

Lockout: Jumper JP1 labeled "LOCK" restricts modification of programmed settings.

Operating Temperature: -20 to 65°C

Storage Temperature: -40 to 85°C

Relative Humidity: 0 to 90% non-condensing

Rate/Totalizer/Batch Controller Features

Rate Display Indication: LED labeled "R" in lower right illuminates when meter is displaying rate or process input.

Alternating Display: Display may be programmed to alternate between rate and total every 10 seconds.

Low-Flow Cutoff: Any input below the low-flow cutoff value will result in a display of zero. May be set from 1 count to 100% FS, user selectable. To disable low-flow cutoff, program cutoff value to zero. Totalizer is based on rate display; inputs below the low-flow cutoff value will not affect the totalizer.

Total Display: 0 to 999,999, automatic lead zero blanking

Total Decimal Point: May be set in any of the following positions: 9.99999, 99.9999, 999.999, 9999.99, 99999.9, 999999.

Total decimal point is independent of process/rate decimal point.

Time Base: Seconds, minutes, hours, or days

Total Conversion Factor: Programmable from 0.00001 to 59999

Totalizer: Calculates total based on rate and field programmable multiplier to display total in engineering units. Total is stored in non-volatile memory.

Totalizer Rollover: Totalizer rolls over when total exceeds 999,999. Relay status reflects the display value.

Totalizer Presets: Up to four, user selectable under Setup menu.

Any set point can be assigned to total and may be programmed anywhere in the range of the meter. Relays assigned to total trip when total reaches the preset value and reset when total is reset to zero or when acknowledged manually. Can be programmed so when the highest preset value is reached the total automatically resets to zero.

Preset Offset: Relays that are assigned to total can be programmed to trip at any point below the next relay's preset value. If preset offset mode is selected the corresponding relay will always trip at a programmed offset value before the next relay trips.

Example: Set point 1 and 2 are set up for total, with Offset selected (under set point 2). If the preset offset is set at 10, (during Set Points programming for set point 1), then relay 1 will trip 10 counts before relay 2.

Programmable Delay on Release: If the meter is programmed to reset total to zero automatically when the highest preset is reached, there will be a delay before the total relays are reset.

This delay can be programmed between 1 and 999 seconds.

Priority Batch Programming: This feature allows the user to quickly change preset values without going into the main menu by holding the ENTER button for more than 3 seconds.

Total Reset: Via front panel ENTER button, external contact closure, or automatically via user selectable preset value.

Total Reset Lockout: Meter may be programmed so Total cannot be reset from front panel.

Relays

Rating: 2 or 4 Form C (SPDT); rated 2 A @ 30 VDC or 2 A @ 250 VAC resistive load; 1/14 HP @ 125/250 VAC inductive loads. Built-in suppression.

Assign to Process/Rate or Total: Any relay may be assigned to process/rate or total (process/rate meters).

Built-in Suppression: Each relay contact is protected by a built-in suppressor (snubber) to prolong the life of the relays and provide a degree of protection against electrical noise caused by inductive loads. Suppressors value: 0.01 μ F/470 Ω , 250 VAC.

Deadband: 0-100% FS, user selectable

High or Low Alarm: User may program any alarm for high or low

Relay Operation: Latching or non-latching

Fail-Safe Operation: Relay coils are energized in non-alarm condition. In case of power failure, relays will go to alarm state. Fail-safe operation may be disabled, by removing jumper J5 located on the options board.

Auto Initialization: When power is applied, relays assigned to total will reflect the state of the accumulated Total value in memory. Relays assigned to process/rate or temperature will reflect the state of the input to the meter.

Relays Reset: User select via jumper array and **SETUP** menu

Total Relays Reset (process/rate meters):

1. When total is reset to zero, if set up for external total reset.
2. After delay has elapsed, if set up for internal total reset.
3. Manual any time, if set up for external total reset. Manual reset resets all manually resettable relays.

Process/Rate & Temperature Relays Reset:

Relays assigned to process/rate or temperature may be programmed to reset in any of the following ways:

1. Automatic reset when the input passes the reset point.
2. Manual reset at any time (via user supplied external contact closure at terminals AK and CM or front panel ACK button). Manual reset resets all manually resettable relays.
3. Automatic plus manual reset at any time. Relays will automatically reset when input passes the reset point. Relays can also be manually reset at any time (via user supplied external contact closure at terminals AK and CM or front panel ACK button). Manual reset resets all manually resettable relays.
4. Manual reset only after alarm condition corrected. Relays can be manually reset only after alarm condition has been corrected (via user supplied external contact closure at terminals AK and CM or front panel ACK button). Manual reset resets all manually resettable relays.

Isolated 4-20 mA Transmitter Output

Scaling Range: Anywhere in range of meter, 501 counts minimum span for process/rate meter; reverse scaling allowed.

Accuracy: $\pm 0.1\%$ FS ± 0.004 mA

Output Loop Resistance:

Power supply	Loop Resistance	
	Minimum	Maximum
24 VDC	10 Ω	600 Ω
35 VDC (external)	600 Ω	1000 Ω

Isolation: 500 V input-to-output or input/output-to-24 VDC supply

External Loop Power Supply: 35 VDC maximum

The PD650, PD655, and PD656 are ideal for loops that consist of a transmitter, a digital meter, and a DCS or computer because they can provide isolated power to drive both the input and output loops.

Batch Control with Varying Batch Sizes

To simplify batch control applications with varying batch sizes, use one or more switches to control the relay outputs. The switch allows the operator to disable the process when changing presets in the meter and then enable the process after all the changes have been made and the process is ready to resume. The switch serves as a "Stop/Ready" control.

See application note AN-0001 at www.predig.com.

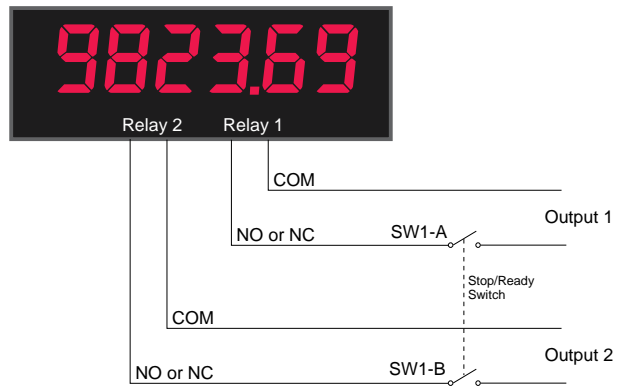

Your Local Distributor is:

Disclaimer

The information contained in this document is subject to change without notice. Precision Digital Corporation makes no representations or warranties with respect to the contents hereof, and specifically disclaims any implied warranties of merchantability or fitness for a particular purpose.

©2009 Precision Digital Corporation. All rights reserved.

LDS650-6_D 05/09